

www.fishman.com

FISHMAN

**USER GUIDE
PREFIX PREMIUM
STEREO ONBOARD BLENDER**

Welcome

Thank you for making Fishman a part of your acoustic experience. We are proud to offer you the finest acoustic amplification products available; high-quality professional-grade tools to empower you to sound your very best. We are confident Prefix Premium Stereo Onboard Blender will both enhance and inspire your music making.

Quick Start

Before you begin, set the controls as shown:

- 1. Plug in** • Use a ¼-inch instrument cable.
- 2. Tune up** • Press the **Tuner** button. When engaged, Tuner mutes the output. Press again to exit Tuner.
- 3. Turn up** • Raise the **Volume** and adjust the **Blend** control to your liking.
- 4. Pickup tone** • Adjust tone controls to your liking.

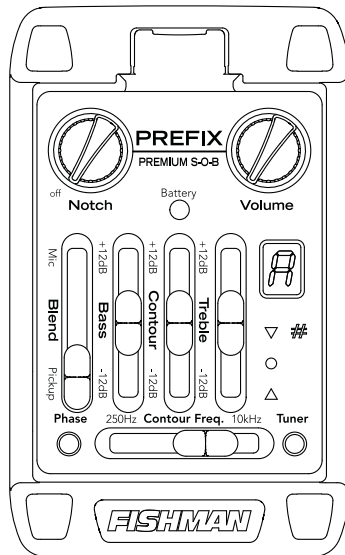

Controls

Volume • For the cleanest signal, set the **Volume** knob as high as possible, without causing distortion or feedback.

Blend • Move the **Blend** slider to change the balance between the pickup and the microphone.

Bass • Boost here to add depth and weight to the sound of the guitar. Note that this control only affects the pickup signal.

Contour EQ • Two sliders (**Contour** and **Contour Frequency**) make up this EQ. The **Contour Frequency** slider lets you tune in on a specific range of sound that you can boost or cut with the **Contour** slider.

Treble • Boost to cut through the mix. Cut to mellow and subdue the sound. Note that this control only affects the pickup signal.

Notch • Tune the **Notch** filter to remove low-end feedback. Raise the **Volume** until feedback occurs, then slowly turn the **Notch** to the right until the feedback is eliminated.

Phase • Use the **Phase** switch to improve bass response at low volume and suppress feedback at high volume. If feedback occurs, push the **Phase** switch. If feedback recurs when you change your location, press the switch again.

Power

Plug in the guitar, and the Prefix Premium S-O-B switches on. The Battery LED will flash once at power-up to tell you the preamp is on.

Low Battery Indicator

When the **Battery** indicator lights steadily, it is time to change the battery. To conserve power, unplug the instrument and turn off the tuner when not in use. Replace the battery by flipping open the preamp body using the latch located at the top of the preamp. Be sure to observe the correct polarity during this installation.

Sample Settings

Fingerstyle

This will add fullness to the bass and definition to the treble.

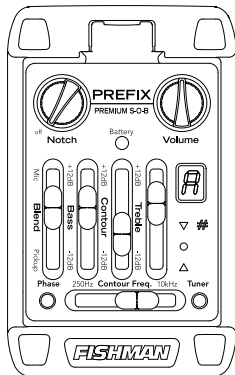

“Scooped” Mid

This setting emphasizes extreme bass and treble

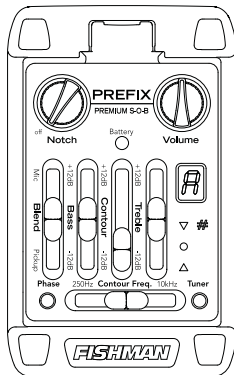

Stereo Operation

A small switch, located on the side of the preamp, lets you choose between mono and stereo operation. Factory preset to mono, you use the onboard controls to affect your mic and pickup sound and connect to your amplifier or PA with a standard guitar cable

If you wish to split the pickup and microphone signals for separate external processing, move this switch to stereo and connect to your amplifier or PA with a stereo "Y" cable. In this mode, the pickup signal goes to the tip output and the microphone goes to the ring output.

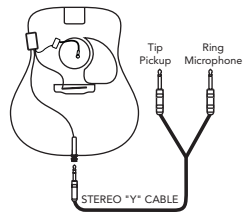
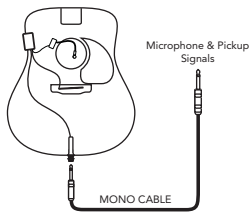
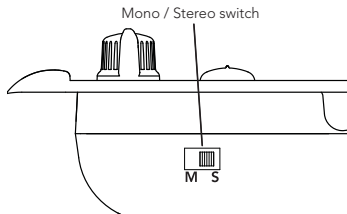

Microphone Trim Adjustment

The microphone and pickup levels are preset at the factory and do not require adjustment. However, a microphone trim control may be adjusted to alter the microphone and pickup balance. Set the **Blend** slider to the center position and adjust the trim control as necessary.

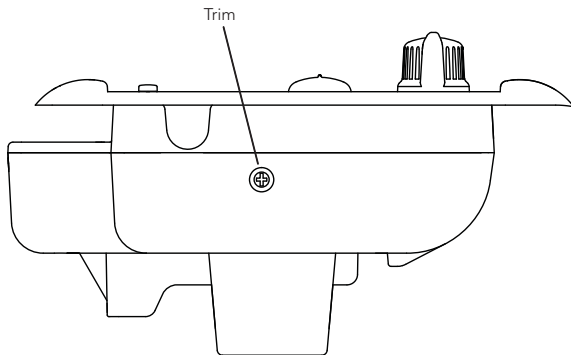

Electrical Specifications

Nominal Input Level:	-20dBV
Input Impedance:	20M Ω
Output Impedance:	Less than 3.5k Ω
Nominal Output Level:	-12dBV
THD:	Less than .04 %, -20dBV input
Noise Floor:	-97dB
Dynamic Range:	102dB
Battery Life:	100hrs. (tuner off)
Notch Filter Range:	30Hz – 300Hz (-15dB)
Bass Control Frequency:	60Hz
Treble Control Frequency:	10kHz
Contour Control Frequency:	250Hz – 10kHz; Q = 0.5

All specifications subject to change without notice.

FISHMAN

www.fishman.com