

[www.fishman.com](http://www.fishman.com)

**FISHMAN<sup>®</sup>**

**USER GUIDE  
LOUDBOX PERFORMER**

# Read Me!

---

Take a few minutes to read through this manual before you power up the Loudbox Performer. To jump in immediately, start with the Important Safety Instructions and the Getting Started sections. While this information will get you on your way, it is not considered a substitute for reading the entire manual.

## Save Your Packing Materials

---

The box and packing materials for the Loudbox Performer were specially designed to protect the amplifier during shipping. Save all this stuff in case you need to re-ship the Loudbox Performer.

## Table of Contents

---

Safety Warnings	3
Welcome	5
Getting started	6
Front Panel	7–9
Rear Panel	10–12
Tone Tips	12–13
About Acoustic Feedback	14
Phantom Power FAQs	15
Stereo Blending	16
Block Diagram	17
Specifications	18–19



Wherever this symbol appears, it alerts you to the presence of uninsulated dangerous voltage inside the enclosure that may be sufficient to constitute a risk of shock.



Whenever this symbol appears, it alerts you to the presence of important operating and maintenance (servicing) instructions in the user's manual for this amplifier.



## Important Safety Instructions

---

To ensure your personal safety and the safety of others, operate this apparatus only after reading these instructions and heeding the warnings listed below.

1. Read these instructions.
2. Keep these instructions.
3. Heed all warnings.
4. Follow all instructions.
5. Do not use this apparatus near water.
6. Clean only with a dry cloth.
7. Do not block the ventilation openings. Install in accordance with the manufacturer's instructions.
8. Do not install near any heat sources such as radiators, heat registers, stoves or other apparatus (including amplifiers) that produce heat.
9. Do not defeat the safety purpose of the polarized or grounding-type plug. A polarized plug has two blades with one wider than the other. A grounding-type plug has two blades and a third grounding prong. The wide blade or the third prong are provided for your safety. If the provided plug does not fit into your outlet, consult an electrician for replacement of the obsolete outlet.
10. Protect the power cord from being walked on or pinched, particularly at the plugs, convenience receptacles and the point where they exit from the apparatus.
11. Use only attachments/accessories specified by the manufacturer.
12. Use only with a cart, stand, tripod, bracket or table specified by the manufacturer, or sold with the apparatus. When a cart is used, use caution when moving the cart/apparatus combination to avoid injury from tip-over.
13. Unplug this apparatus during lightning storms or when unused for long periods of time.



14. Refer all servicing to qualified service personnel. Servicing is required when the apparatus has been damaged in any way, such as a power-supply cord or plug is damaged, liquid has been spilled or objects have fallen into the apparatus, the apparatus has been exposed to rain or moisture, does not operate normally, or has been dropped.

Do not expose the apparatus to dripping or splashing liquids and do not place objects filled with liquids (such as a beverage container or a vase) on the apparatus.



Disconnect device is AC inlet or power switch.

**Warning:** To reduce the risk of fire or electric shock, do not expose this apparatus to rain or moisture.

## Hear This!

---

The Loudbox Performer amplifier is capable of cleanly reproducing the sound of your instrument at very high volume levels. Prolonged repeated exposure to high sound pressure levels (SPLs) without protection can cause permanent hearing loss. OSHA has set guidelines and specified permissible sound-exposure limits for those who work in high SPL environments.

### Permissible noise exposures

Duration per day, hours	Sound level dBA slow response
8	90
6	92
4	95
3	97
2	100
1½	102
1	105
½	110
¼ or less	115

To ensure against permanent hearing loss, wear hearing protection when you perform with amplification.

## Welcome . . .

---

. . . and thank you for choosing the Fishman Loudbox Performer! Our passion for acoustic instruments inspired us to create this amp—it is our sincere wish that the Loudbox Performer will inspire you as well!

With its unique tri-amplified design, the potent and portable, two-channel, 130 watt Loudbox Performer delivers more serious acoustic tone and volume than any other amp in its class. The secret to the Loudbox Performer's sound lies in its three power amps and two-way speaker system. This powerful combination results in higher sound pressure levels and cleaner acoustic tones, watt-for-watt, than comparable acoustic amps.

You'll find this lightweight and compact amp is as comfortable in your home studio as it is onstage. It easily passes the "one-trip" test, for those times you carry both your instrument and your amp to the car or into the club.

The two-channel Loudbox Performer brings together a wish list of the essential features you've been looking for. The front panel includes inputs for acoustic instruments, a microphone and a CD player or drum machine. Dual EQ sections include bass, midrange and treble controls for easy, effective tone shaping. Vanquishing troublesome acoustic feedback is simple with independent anti-feedback filters and phase switches for each channel. We also include five digital effects you can really use: two halls, two plates, and a smooth chorus. A convenient mute switch keeps things quiet when you tune up or take a break. The Loudbox Performer also features a headphone jack for silent jamming or practicing.

On the rear panel, good things come in threes with D.I.s for channels 1 & 2, plus a third summed Mix-D.I. output (watch your soundperson smile). For pedal-heads, each channel has its own effects loop, a tuner out (Ch. 1) and a ¼" jack for a remote mute switch. With the Loudbox Performer on the floor, the speaker's ten-degree tilt-back angle helps to project your sound up to ear level.

So what are you waiting for? Grab your guitar and your Loudbox Performer and go out and make some music!

If you have questions or comments, please contact us through the Service and Support section of our website at [www.fishman.com](http://www.fishman.com).



# Getting Started

Here are some basic setup tips to help get you going. To operate the Loudbox Performer safely, please read the entire manual, especially the Important Safety Instructions on page 3.

If your amplifier has an operating voltage of 120V, plug the provided AC line cord into the back of the amplifier.

If your amplifier operates at 230V, you must supply your own detachable power cord. The cord you supply must have an IEC-style 320 connector at one end and a male AC plug appropriate for your area at the other.

























1. Locate the Power switch (above the rear panel power cord terminal) and switch it off (down position), then connect the power cord.
2. Plug the Loudbox Performer into an electrical outlet with the appropriate AC voltage.



NOTE: Operate the amplifier only at the voltage indicated in the check box on the rear panel. Do not defeat the ground prong on the AC cable; the safe operation of this amplifier depends on a proper ground connection.



3. Push in the Mute switch and turn on the Power switch.
4. Connect your instrument to the Channel 1 input with a shielded ¼" cable.
5. Play aggressively and raise Channel 1 Gain until Clip LED flashes, then back off the Gain until no clipping occurs.
6. Set the controls as illustrated below.
7. Push the Mute switch (out) and slowly raise the Master Volume to the desired level.

Loudbox Performer   Acoustic Instrument Amplifier		Gain	Low	Mid	High	Anti Feedback	Phase	FX Level	Digital FX	Level	Master Volume
											
											

# Front Panel

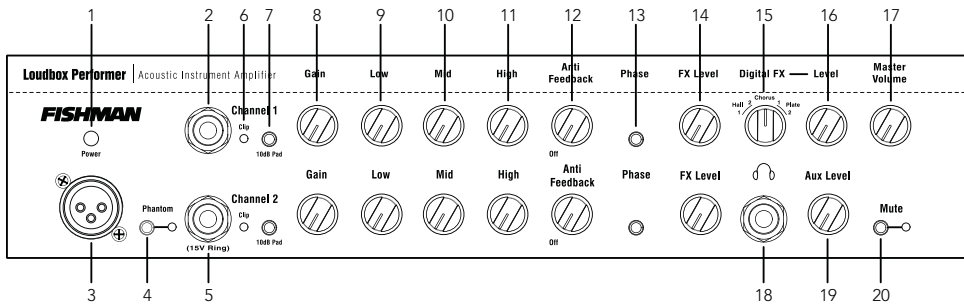

## 1. Power

Lights up when the amplifier power is on. The Power switch is located behind the amp above the AC power cord terminal.

## 2. Channel 1 input

Accepts all types of passive or active acoustic pickups.

## 3. Channel 2, XLR input

Plug in a balanced mic here for vocal or for your instrument. The Loudbox Performer makes an excellent mini-PA or vocal monitor. You may also connect an outboard preamp with balanced XLR out to this input.

Note: If you attempt to plug in both the Channel 2 XLR and 1/4" inputs at the same time, the XLR shuts off.

## 4. Phantom power switch

Provides 24V to the XLR input, for a condenser microphone.

Provides 15V to the ring contact of Channel 2's 1/4" input, for instruments with mini-electret microphones.

Note: Push the Mute switch in before you turn on the phantom power, to avoid a loud "pop."

For more information on phantom power, see page 15.

## 5. Channel 2, ¼ input (stereo)

Accepts all types of passive or active acoustic pickups. The Ring contact of this stereo TRS input is tied to Channel 1. An instrument with two signal sources (such as pickup and mini-mic) can be routed via stereo cable through this jack to both Channels 1 and 2 (see page 16 for setup).

Note: Unplug Channel 1 input before you use Channel 2's ¼" input for stereo blending. If you use both ¼" inputs simultaneously, Channel 1 takes priority and shuts off the Channel 2 Ring signal.

With this setup, your pickup and onboard mini-mic can be EQ'd and blended separately. Wire the mini-mic to Ring and the pickup to Tip and follow the manufacturer's instructions. Turn on Phantom 15V power if your mini-mic requires it. Stereo cables are available through your Fishman dealer.

Note: Items 6–14 are identical for both channels.

## 6. Clip LED

The Clip LED will light when the Gain level is too high and the signal becomes distorted. If the light comes on when you play, lower the Gain until the distortion goes away.

## 7. 10dB Pad

If you have a high output pickup and the Clip LED comes on at low Gain settings, push this switch in to put your pickup into a more useable range.

## 8. Gain

Use the Gain knob to set the level of the signal. If the Clip LED flashes when you play, lower the Gain until the flashing stops. If either channel is unused, set its Gain to 7 o'clock (off).

## 9. Low

Boost here to add weight to the sound. In general, boost bass at low volumes and flatten it out (or cut) at higher levels. With the dial set at 12 o'clock, the control is effectively out of the circuit.

## 10. Mid

This control affects how well the instrument blends in or stands out in the mix. At loud volumes a midrange cut will achieve a more natural sound. With the dial set at 12 o'clock, the control is effectively out of the circuit.

## 11. High

Boost highs to add "air" to the sound of the instrument. With the knob set at 12 o'clock, the control is effectively out of the circuit.

## 12. Anti Feedback

If you encounter low-frequency feedback, sweep this control to isolate and eliminate it. Many guitars will benefit with the Anti Feedback knob set at about 10 o'clock. The Anti Feedback filter is off at the 7 o'clock position. To read more about acoustic feedback, see page 14.

## 13. Phase

Use the Phase switch in conjunction with the Anti Feedback filter to eliminate acoustic feedback. To read more about acoustic feedback, see page 14.

## 14. FX Level

Controls the amount of digital effects in the channel. Generally set this above the Master FX Level.

## 15. Digital FX (select)

These built-in effects have been specially chosen and voiced for acoustic instruments.

## 16. Digital FX Level (master)

Set the overall level of the Digital FX with this knob. In general set this lower than the individual Channel 1 and 2 FX Levels.

### Digital FX Programs

1. Hall 1
2. Hall 2
3. Chorus
4. Plate 1
5. Plate 2

## 17. Master Volume

Set the overall level of the Loudbox Performer with the Master Volume. In general put the Master Volume as high as possible (2 o'clock to 5 o'clock) to achieve the cleanest sound.

## 18. Headphone jack

When you plug in stereo headphones here, the speakers shut off. This output monitors Channels 1 & 2 and the Aux input, so you can play along with pre-recorded music through the headphones.

## 19. Aux Level

Use this to control the level of the device you plug into the Aux input. Note that the Aux channel is independent of the Mute switch, so you can play pre-recorded music on your breaks. If the Aux channel is unused, set the Aux level to off.

## 20. Mute

The Mute switch shuts off the signals from Channels 1 and 2 to the speakers and all the XLR outputs. The mute does not affect the Aux channel, the Tuner out or the effects sends.

# Rear Panel

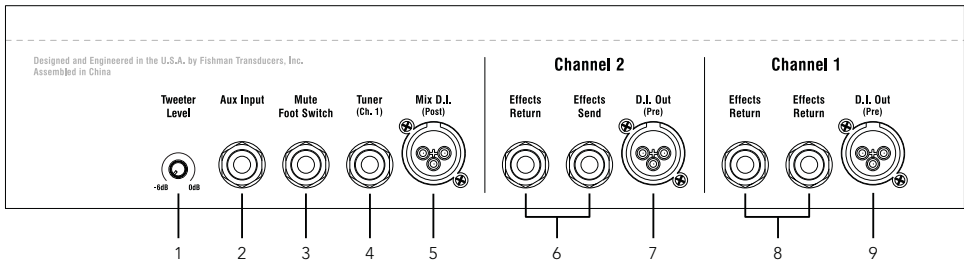

## 1. Tweeter Level

Set the front panel controls flat and adjust the tweeter level to where it sounds best to you.

## 2. Aux Input

Plug in a line level stereo audio source such as a CD or MP3 player in this input. The ¼" stereo (TRS) Aux Input mixes the signals to mono when amplified, but will retain the source's stereo image through the headphones jack.

## 3. Mute Foot Switch

Plug a mono, on/off (latching type) foot switch into this jack for remote access to the Mute. The Mute Foot Switch duplicates and overrides the front panel Mute switch.

## 4. Tuner out

Plug in an electronic tuner here. This output receives only the Channel 1 signal and is independent of the mute, so you can tune with the speakers and the XLR outs muted. The Tuner out can also be used as pre-EQ unbalanced D.I. out for Channel 1.

## 5. Mix D.I. (Post)

Plug in here when you wish to send signals from both Channel 1 and 2 to a mixing console or a slave amplifier. This post-EQ output is always ground isolated to prevent ground loop hum.

## 6. Channel 2 effects loop (serial)

Patch an external effect (delay, reverb, chorus) through these jacks. Use a standard ¼" shielded instrument cable to connect the Channel 2 send to the input of the effect. Connect the Channel 2 return jack to the output of the effect. The Channel 2 loop is located post-EQ and is compatible with battery-operated stompbox-style effects processors.

## 7. Channel 2 D.I. Out (Pre-EQ)

You'll find that this true direct output produces an uncolored signal that is exceptional for recording. Use this output when you want a flat D.I. signal to go to the board. In this case you leave it to the soundperson or recording engineer to dial up your tone and effects from the console. This pre-EQ output is always ground isolated to prevent ground loop hum.

## 8. Channel 1 effects loop (serial)

Patch an external effect (delay, reverb, chorus) through these jacks. Use a standard ¼" shielded instrument cable to connect the Channel 1 send to the input of the effect. Connect the Channel 1 return jack to the output of the effect. The Channel 1 loop is located post-EQ and is compatible with battery-operated stompbox-style effects processors.

## 9. Channel 1 D.I. Out (Pre-EQ)

You'll find that this true direct output produces an uncolored signal that is exceptional for recording. Use this output when you want a flat D.I. signal to go to the board. In this case you leave it to the soundperson or recording engineer to dial up your tone and effects from the console. This pre-EQ output is always ground isolated to prevent ground loop hum.

## Power switch

Lower the master volume or engage the Mute switch before you turn on the amp. Flip the power switch to the up position and it will light, indicating the amp is on.

## AC power

Operate the amplifier only at the voltage indicated in the check box on the rear panel.

For 120V amplifiers purchased in the USA, Canada and Mexico, plug in the supplied detachable AC power cable.

For 230V amplifiers purchased outside the USA and Canada, you will need to supply your own detachable AC cable. This cable must have an IEC-style 320 connector at one end, and a male AC plug appropriate for your region at the other.



Disconnect device is AC inlet or power switch.

## Fuse holder

The fuse is located within the AC power receptacle on the back of the amp. Access the fuse compartment with a small slotted screwdriver.

For 120V amplifiers purchased in the USA and Canada, replace the fuse with: Littelfuse® type 218002 or equivalent 5 x 20mm, 2A, 250V, time-delay fuse.

For 230V amplifiers purchased outside the USA and Canada, replace the fuse with: Littelfuse® type 218001 or equivalent 5 x 20mm, 1A, 250V, time-delay fuse.

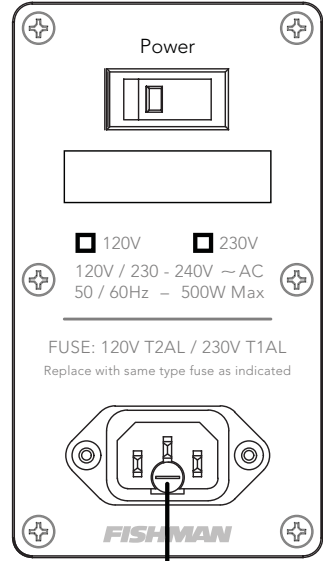

Fuse Holder

## Tone Tips

---

You can find a balanced tone with the Loudbox Performer when you hear how tone changes as the volume rises.

### Set up

For reference, start with the tone controls flat (straight-up, twelve o'clock). In this position, there is no equalization applied to your sound. Begin at a very low volume and work your way up. As you turn up, try adjusting the Loudbox Performer's tone controls as recommended below.

# 1. Low volume

At a low volume (just above conversation level) our ears are not very sensitive to bass and treble, so give the Low and High controls a good boost. Try three o'clock on the dial.

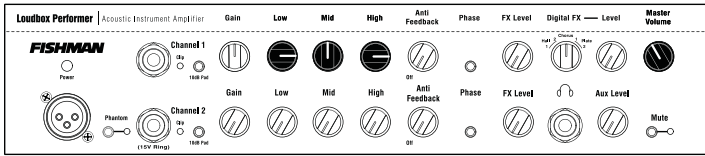

# 2. Medium volume

At intermediate levels, when you need to raise your voice to be heard over the music, the human ear is quite sensitive to midrange. Cut the Mid control to about ten o'clock or to your taste. At this level our perception of bass and treble starts to catch up to the rest of the tonal spectrum, so you can back off the Low and High controls slightly for good tonal balance.

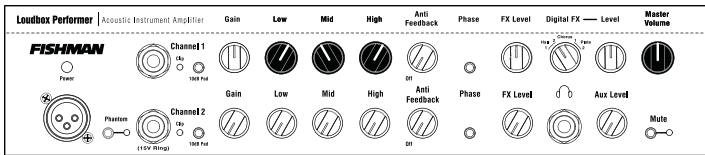

# 3. High volume

At loud levels, when you must shout to be heard over the music, your ears (and your audience) will benefit from a deep midrange cut. Set the Mid dial between nine and seven o'clock. Our perception of bass and treble "flattens out" at high volumes, so you won't need much, if any, Low or High boost. Set the Low and High knobs to between twelve and one o'clock. In many cases you can also improve the tone at very high volume if you cut bass. Try setting the Low knob between ten and eleven o'clock.

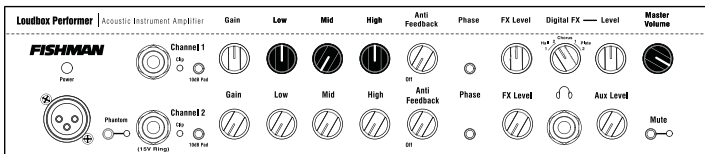

# About Acoustic Feedback

Feedback usually occurs in the lowest octave of your instrument, generally with two notes about a half step apart. The lower type of feedback (cavity resonance) starts when the sound pressure coming out of the speakers excites the resonant air chamber inside your instrument. We have found that it is effective to tune out an instrument's cavity resonance feedback with the Anti Feedback (notch filter) in the Loudbox Performer. For acoustic guitar this occurs at G# on the low E-string, or at about 100Hz. Turn the Anti Feedback knob to about 11 o'clock to dial out this resonance. Note that the circuit can be effectively defeated by moving the dial to the Off (7 o'clock) position.

The higher range of feedback (top resonance) usually starts about a half or whole step above cavity resonance of the instrument. Top resonance feedback happens when the sound pressure coming off the speakers excites the resonant frequency of the soundboard of your instrument. For acoustic guitar this occurs at A and above on the low E-string. Push the Phase switch in and out until you find the position that subdues top resonance feedback.

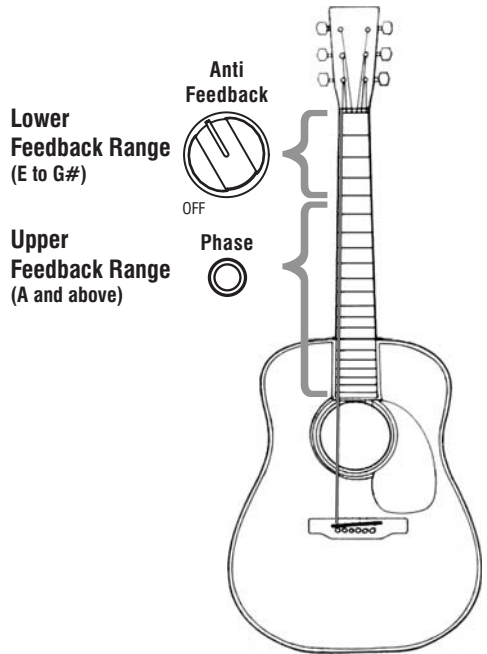

## Phantom Power FAQs

---

**Q:** I have heard 24V phantom power can damage some audio devices. True?

**A:** Yes, phantom power can damage the following:

1. An unbalanced dynamic mic that has been modified for XLR.
2. A balanced line-level device that is not designed to accept phantom power (eg, some effects processors). Contact the manufacturer to confirm compatibility.
3. Some older balanced wireless receivers can be damaged by phantom power. Consult the manufacturer of the wireless unit for compatibility.
4. An instrument preamp or stompbox with an unbalanced output that is modified for XLR.

Important note: Turn off phantom power if you plug any of the above into the XLR input.

**Q:** Which devices are safe with 24V phantom power?

**A:** All the following can be used safely with phantom power:

1. All balanced condenser microphones.
2. All balanced dynamic microphones.
3. Many new wireless units. Check with the manufacturer for compatibility.
4. A preamp/D.I. designed for phantom-power operation, such as the Fishman Pro-EQ Platinum.

# Stereo Blending

If your instrument has two signal sources (typically mini-mic and pickup) and stereo output, you may route these signals into separate channels of the amp and blend them independently for your own custom mixes.

- 1) Plug in a stereo (TRS) instrument cable between your guitar and the Channel 2, 1/4" input.
- 2) Pickup (Tip) is routed to Channel 2 and Mic (Ring) is routed to Channel 1.
- 3) Turn on phantom power if mini-mic requires it.

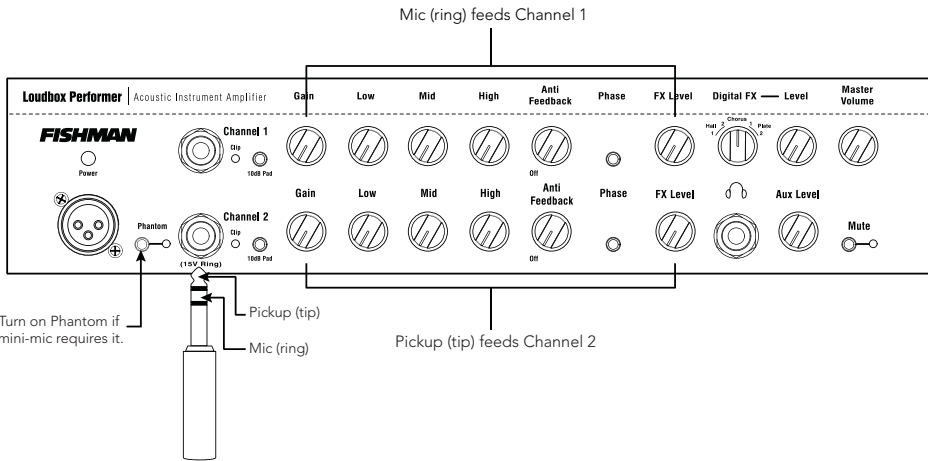
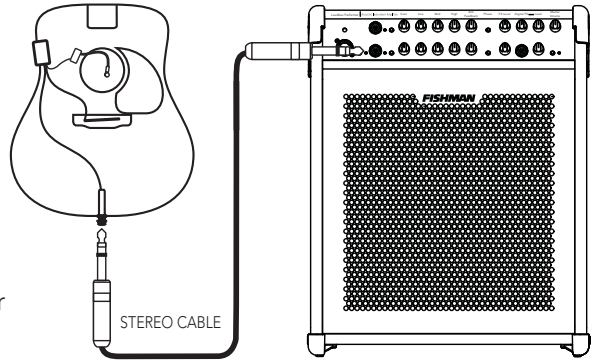

# Block Diagram

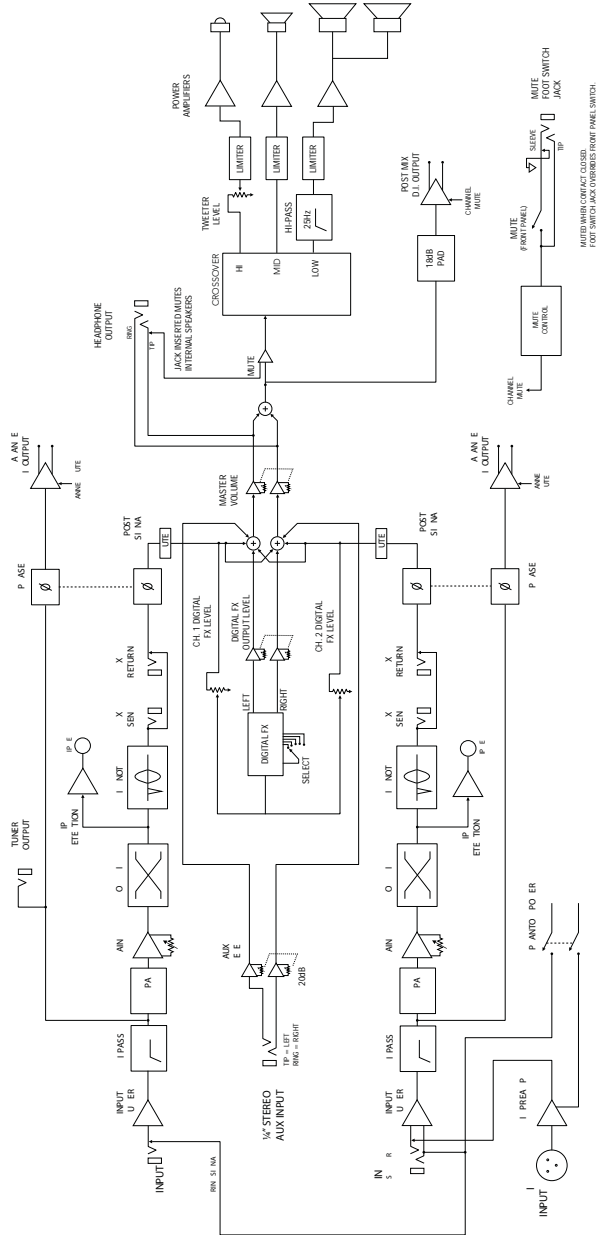

# Technical Specifications

---

## Rated power:

Cumulative	130Wrms
Woofer Amp	80Wrms continuous
Midrange Amp	40Wrms continuous
Tweeter Amp	10Wrms continuous
All measurements @ nominal line 120V, 60Hz	

## Acoustic response:

SPL @ 1 Meter	117dB SPL
Frequency Response	80Hz – 20kHz $\pm$ 4dB

## Power consumption: 200W max

## Input impedance:

Ch. 1	10M $\Omega$
Ch. 2, ¼" Jack (Tip)	10M $\Omega$
Ch. 2, ¼" Jack (Ring)	10M $\Omega$ , 10k $\Omega$ with 15V phantom power
Ch. 2, XLR Input	2.4k $\Omega$ Balanced
Aux Input (stereo)	10k $\Omega$

## Nominal input level:

Ch. 1	-20dBV/-10dBV with 10dB pad
Ch. 2, ¼" Jack (Tip)	-20dBV/-10dBV with 10dB pad
Ch. 2, ¼" Jack (Ring)	-20dBV/-10dBV with 10dB pad
Ch. 2, XLR Input	-40dBV/-30dBV with 10dB pad
Aux Input (stereo)	-10dBV

## Maximum recommended input level:

Ch. 1	6dBV
Ch. 2, ¼" Jack (Tip)	6dBV
Ch. 2, ¼" Jack (Ring)	6dBV
Ch. 2, XLR Input	-14dBV
Aux Input (stereo)	6dBV

## Phantom power (Ch. 2 only):

XLR Input	24Vdc/6.8k $\Omega$ DC source impedance per pin
¼" Jack (Ring)	15Vdc/10k $\Omega$ DC source impedance

## Tone controls and Anti Feedback (Ch. 1 and Ch. 2):

Low	$\pm$ 10dB @ 100Hz (shelving)
Mid	$\pm$ 12dB @ 1.2kHz (resonant)
High	$\pm$ 12dB @ 10kHz (shelving)
Anti Feedback range	-14dB @ 20 – 400Hz (Hi-Q resonant notch)

We reserve the right to change any of the the specifications and information in this manual without notice.

**Digital effects:**

Program 1	Hall 1
Program 2	Hall 2
Program 3	Chorus
Program 4	Plate 1
Program 5	Plate 2

**Headphone Jack**

Output Impedance	22 Ohm
Max Output Level	18.5dBV (rms)
Nominal Output Level	-10dBV

**Channel 1 & 2 D.I. Out**

Output Impedance	600Ohm balanced Phantom power tolerant, ground isolated
------------------	--

**Channel 1 & 2 Effects Sends:**

Output Impedance	2.2kOhm
Output Voltage	+3dBV (1.4Vrms max) -10dBV Nominal

**Channel 1 & 2 Effects Returns:**

Input Impedance	20k Ohm
Input Voltage	+3dBV (1.4Vrms max) -10dBV Nominal

Sends and returns are compatible with battery operated effects processors

**Mix D.I. out:**

Output Impedance	600Ohm balanced Phantom power tolerant, ground isolated
------------------	--

**Tuner out:**

Output Impedance	5kOhm
------------------	-------

**Speaker system:**

Woofer	6.5" paper cone
Midrange	4.5" polypropylene cone
Tweeter	1" soft dome, rare earth magnet, ferrofluid cooled
Tweeter Level	Up to 6dB cut
Crossover	600Hz, 4kHz (Tri-amplified with active crossover)
Woofer and midrange installed in	separate isolated and damped compartments
Baffle Angle	Upright position 10 degrees With kickstand 45 degrees

**Physical:**

Dimensions	19.5" x 16" x 11.5" (49.5cm x 40.5cm x 29cm)
Weight	35 lbs (16 kg)

***FISHMAN***

[www.fishman.com](http://www.fishman.com)